

BrainChild NC200 User's Manual

CONTENTS

- 1. Overview
 - 1.1 Introduction
 - 1.2 Ordering Code
 - 1.3 Mini-jumper Setting
 - 1.4 Keys and Displays
 - 1.5 Operation Flowchart
 - 1.6 Parameter Descriptions
- 2. Installation
 - 2.1 Product Views
 - 2.2 Connecting NC200 to Power and Heater
 - 2.3 Connecting NC200 to Sensor
 - 2.4 Networking NC200'S
- 3. Operation
 - 3.1 Lockout
 - 3.2 Display Address
 - 3.3 Alarm
 - 3.4 PV Shift
 - 3.5 Auto-tuning
 - 3.6 Manual Control
- 4. Specifications
- 5. Error Message

1. Overview

1.1 Introduction

The NC200 is a compact fuzzy logic plus PID temperature controller with J or K type thermocouple or RTD input. Multiple units (up to 247 units) can be networked together with 4P4C modular connector. Each unit auto-tunes on initial setup to provide the best response for each heater. The NC200 is powered by 90-250VAC supply and contains a solid state relay as its control output. The solid state relay can drive the heater directly through a plug-in connector. The major features of the unit are as following:

- * COMPACT SIZE
- * EASY INSTALLATION
- * SELF ADDRESSING
- * FAST COMMUNICATION SPEED

1.2 Ordering Code

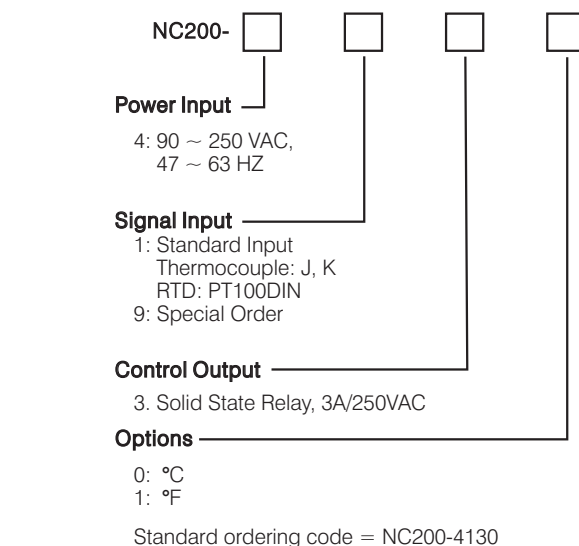

1.3 Mini-jumper Setting

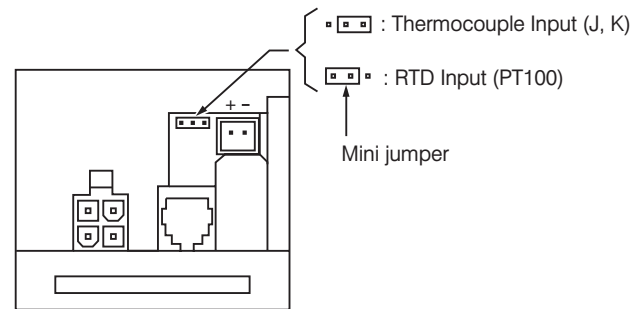

Figure 1 Mini-jumper setting

The mini-jumper on the PCB is used to select the sensor type for the controller.

1.4 Keys and Displays

- Scroll key :
- This key is used to select a parameter to be viewed or adjusted.
- Up key :
- This key is used to increase the value of selected parameter.
- Down key :
- This key is used to decrease the value of selected parameter.
- Address key: and
- Press both scroll key and down key to display the communication address of the unit.
- Reset key: and
- This key is used to:
1. Revert the display to indicate the process value.
 2. Stop the manual control mode, auto-tuning mode and calibration mode.
 3. Clear the message of communication error and auto-tuning error.
- Enter key: Press for 4 seconds or longer to:
1. Enter setup page. The display shows [Cod].
 2. Enter manual control mode during output value [H_] is selected.
 3. Enter auto-tuning mode during [R-t] is selected.
- Press for 6 seconds will display the process value.

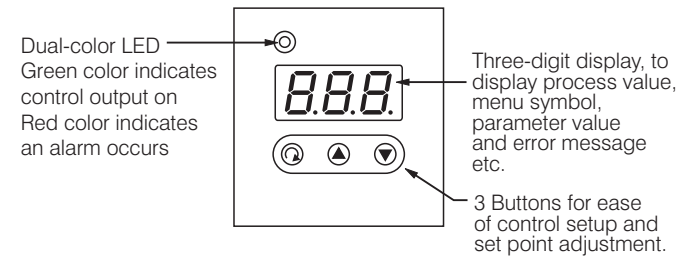

Figure 2 Front Panel Description

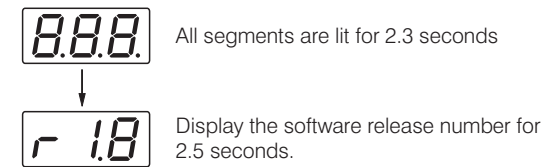
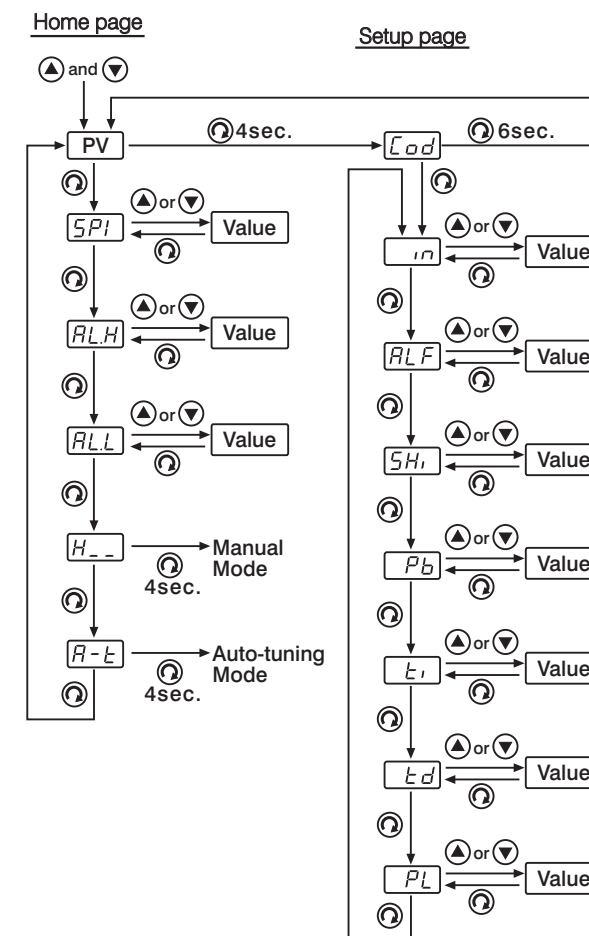

Figure 3 Display of Initial Stage

1.5 Operation Flowchart



1.6 Parameter Descriptions

Register Address	Parameter Notation	Parameter Description	Range	Default Value	Data Type
0	SP1	Set point value for control	Low: -17.8 °C (0 °F) High:500 °C (932 °F)	25 °C (77 °F)	R/W
1	ALH	High alarm set point	ALF=P.Hi, P.Lo, P.HL Low: 25 °C (77.0 °F) High:500 °C (932.0 °F) ALF=D.Hi, D.Lo, D.HL Low: 5 °C (9.0 °F) High:40.0 °C (72.0 °F)	10 °C (18 °F)	R/W
2	ALL	Low alarm set point	ALF=P.Hi, P.Lo, P.HL Low: 0 °C (32.0 °F) High:ALH-5 °C (ALH-9.0 °F) ALF=D.Hi, D.Lo, D.HL Low: -40 °C (-72.0 °F) High:-5 °C (-9.0 °F)	-10 °C (-18 °F)	R/W
3	IN	Input sensor selection	0. Jt : J type thermocouple 1. Lt : K type thermocouple 2. Pt : PT 100 ohms (DIN)	°F : 0 °C : 1	R/W
4	ALF	Alarm function for alarm output	0. PH : Process high alarm 1. PL : Process low alarm 2. PHL : Process high/low alarm 3. dH : Deviation high alarm 4. dL : Deviation low alarm 5. dHL : Deviation high/low alarm	5	R/W
5	SHI	PV shift (offset) value	Low: -100 °C (-180 °F) High:100 °C (180 °F)	0 °C (0 °F)	R/W
6	PB	Proportional band value	Low: 1 °C (2 °F) High:500 °C (900.0 °F)	10 °C (18 °F)	R/W
7	TI	Integral time value	Low: 1 High:900 sec	100	R/W
8	TD	Derivative time value	Low: 0 High:300.0 sec	25	R/W
9	PL	Power limit	Low: 0 % High:100%	100%	R/W
10	ADL	Voltage calibration low coefficient	Low: -1999 High:1999	—	R/W
11	ADH	Voltage calibration high coefficient	Low: -1999 High:1999	—	R/W
12	RDL	RTD calibration low coefficient	Low: -1999 High:1999	—	R/W
13	RDH	RTD calibration high coefficient	Low: -1999 High:1999	—	R/W
14	CJL	Cold junction calibration low coefficient	Low: -1999 High:1999	—	R/W
15	CJH	Cold junction calibration high coefficient	Low: -1999 High:1999	—	R/W
17	COD	Security code	Low: 1 High:900	666	R/W
20	PV	Process value	Low: -17 °C (0 °F) High:500 °C (932 °F)	—	R
21	SV	Set point value	Low: -17 °C (0 °F) High:500 °C (932 °F)	—	R
22	MV	Control output value	Low: 0 High:100%	—	R
23	STA	Status word	Low: 0 High:527	—	R

2. Installation

2.1 Product Views

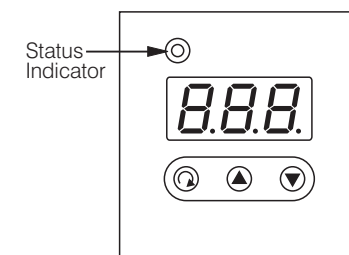

Figure 4 Front View

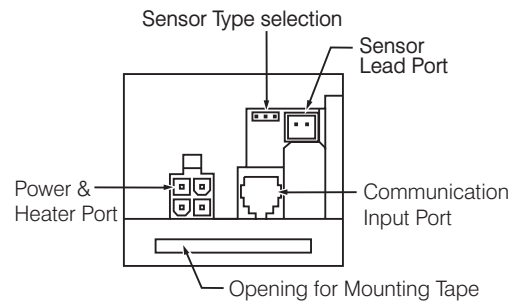

Figure 5 Left Side View

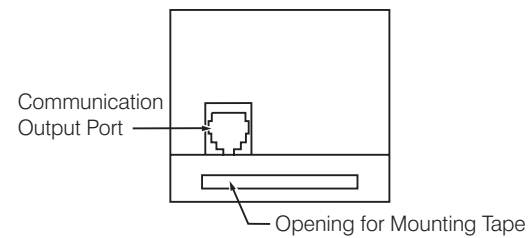

Figure 6 Right Side View

2.2 Connecting NC200 to Power and Heater

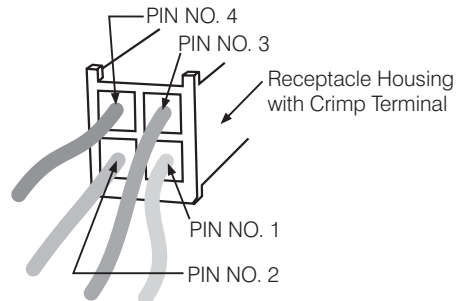

Figure 7 Power Wiring

Pin No.1: to Ground
 Pin No.2: to Neutral Lead of Power Input
 Pin No.3: to Line Lead of Power Input and One Lead of Heater
 Pin No.4: to Another Lead of Heater
 Receptacle Housing: Use ALEX 9357-4
 Crimp Terminal: Use ALEX 4256T series

2.3 Connecting NC200 to Sensor

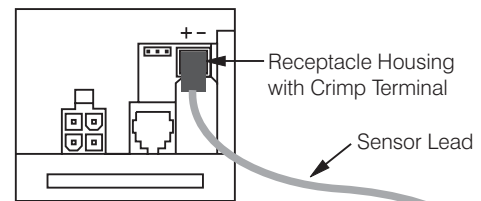

Figure 8 Sensor Wiring

The Polarity + of Sensor Lead should be connected to the left side of Sensor Lead Port.
 Receptacle Housing: Use ALEX 9566-02 G
 Crimp Terminal: Use ALEX 9558-TP

2.4 Networking NC200's

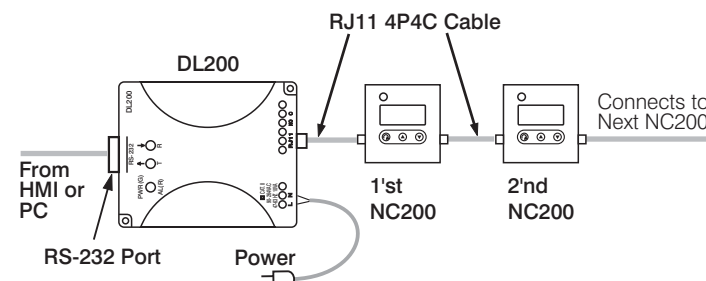

Figure 9 Communication installation

Figure 9 shows the proper direction to install the RJ11 4P4C communication cable. The first unit is connected from the Data Logger DL200 to its communication input port (Left Side) which is at same side of the sensor input port. The first unit is connected its communication output port (Right Side) to the communication input port of the second unit. Each unit is connected its communication output port to the communication input port of next unit. The last unit leaves the communication output port open.

3. Operation

3.1 Lockout

The parameter CODE (displayed as \boxed{Cod}) provides a security code for up-down key operation. If and only if the value of CODE is adjusted to be equal to 666, the up-down key functions are enabled.

3.2 Display Address

When you press both scroll key and down key the value of address of the unit will be shown on the display. **Exception case:** If the displayed value is equal to zero, it indicates that the network linkage is abnormal.

3.3 Alarm

The controller has 6 alarm functions and when one of alarm functions occurs, the LED indicator will show red color. The alarm functions are described as following Figure:

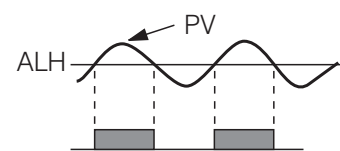

Figure 10 Process High Alarm

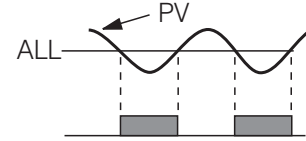

Figure 11 Process Low Alarm

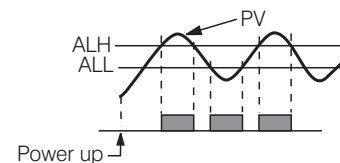

Figure 12 Process High/Low Alarm

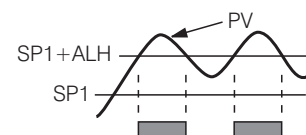

Figure 13 Deviation High Alarm

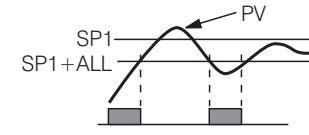

Figure 14 Deviation Low Alarm

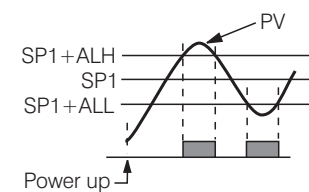

Figure 15 Deviation High/Low Alarm

Please note when the process high/low or deviation high/low is selected for alarm function, the alarm is disabled during the power up stage and the alarm is enabled until the process value enters the high/low band.

3.4 PV Shift

In certain applications it is desirable to shift the controller display value from its actual value. This can be easily accomplished by using the PV shift function.

For example, the default value of SHI is zero. Now if PV is equal to 100(°C), and SHI is changed to 20, then PV will be changed to 120 (°C).

3.5 Auto-tuning

The auto-tuning is applied in cases of :

- (1) Initial setup for a new process.
- (2) The set point is changed substantially from the previous auto-tuning value.
- (3) The control result is unsatisfactory.

Operation:

- (1) The system has been installed normally.
- (2) Set the point to a normal operating value or a lower value if overshooting beyond the normal process value is likely to cause damage.
- (3) Press scroll key until $\boxed{R-E}$ appears on the display.
- (4) Press scroll key for 4 seconds, the display value will begin to flash and auto-tuning procedure is beginning.
- (5) After the PID auto-tuning cycle completes, the PID constant values are saved inside of the unit and the display ceases to flash.

3.6 Manual Control

Press the scroll key until $\boxed{H-}$ appears on the display. Now the display indicates the percentage value of control output. Press the scroll key for 4 seconds, the display value will begin to flash and control output value can be changed by up and down keys.

4. Specifications

Power

90 ~ 250 VAC, 47 ~ 63 Hz, 800VA maximum

Input

Type	Range	Accuracy	Input Impedance
J	-17.8 °C ~ 500 °C (0 °F) (932 °F)	± 2 °C	1 MΩ
K	-17.8 °C ~ 500 °C (0 °F) (932 °F)	± 2 °C	1 MΩ
PT100 (DIN)	-17.8 °C ~ 500 °C (0 °F) (932 °F)	± 1 °C	1.3 KΩ

Output (Solid state relay)

Rating : 7A @25°C, 3.5A @47.5°C ambient temperature, 90 ~ 250 VAC, 47 ~ 63Hz.
 See Fig.16 Load derating curve

Switch ON-OFF: Zero crossing triggering
 Insulation resistance: 1000 Mohms min. at 500 VDC
 Dielectric strength: 2500 VAC for 1 minute.

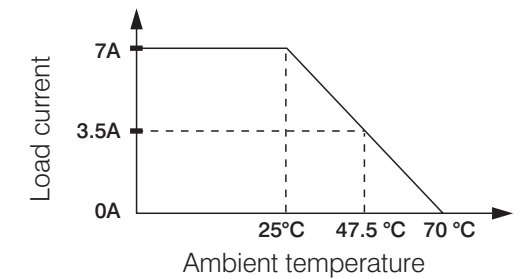

Figure 16 Load Derating Curve

Data Communication

Interface: Differential driver/receiver
 Protocol: Proprietary Protocol
 Baud Rate: 92.16 K bits/sec.

Control Mode

Action Reverse (heating)
 PID mode:

PB= 1-500 °C
 TI= 1-900 sec.
 TD= 0-300 sec.

Cycle time: 2 seconds
 Manual control: 0-100%
 Auto-tuning: Cold start and warm start
 Power limit: 0-100%

Environmental & Physical

Operating temperature: -10°C ~ 50°C
 Storage temperature: -40°C ~ 60°C
 Humidity: 0 ~ 90%RH (non-condensing)
 Altitude: 2000 m maximum
 Insulation resistance: 20 Mohms min. (at 500VDC)
 Dielectric strength: 1350VAC, 50/60 Hz for 1 minute
 Vibration resistance: 10-55 Hz, 10 m/s² for 2 hours
 Shock resistance: 200 m/s² (20g)
 Dimensions:
 NC200 ----- 50.3(W) x 52.4(L) x 45(H)
 Weight ----- 112 grams

Approval standards

Safety: EN61010-1

Protective class: IP20

EMC: EN61326

5. Error Message

Display symbol	Error Description	Solution
RdE	Hardware failure occurs	Return to factory for repair
SbE	Sensor break occurs	Replace input sensor
CJE	Cold junction error occurs	Return to factory for repair
RtE	Auto-tuning procedure fails	1. Never change set point value during auto-tuning procedure. 2. Retry auto-tuning.